

CAMBLOCK PLUS

3.81mm Pitch Pluggable Rising Clamp Terminal Blocks

- 2-12 pole solid block
- Pluggable male-female connectors
- Closed headers
- Horizontal & vertical female plug styles
- Polarised mouldings
- Moulded in green UL94-V0 flame retardant PA66
- Professional rising clamp terminals
- 1.0mm² (28-16AWG) solid & stranded cable
- Anti solder wicking
- Captive screws
- Guided pin alignment
-  approved

SPECIFICATION

Rating	UL=8A/300V, VDE=10A/250V
Insulation resistance	500MΩ/500V
Withstand Voltage	AC2000V/1min
Contact Resistance	20mΩ (max)
Working Temperature	-40°C to 105+°C
Mouldings	UL94-V0 Flame retardant PA66
Pin/Terminal	Tin plated brass
Rising Clamp	Brass, nickel plated
Screw/Torque	M2 Steel, zinc Plated 0.2Nm
Recommended PCB hole size	ø1.4mm

Female Connector

TYPE NO.	POLES	LENGTH
CTBP92HE/2	2	8.4mm
CTBP92HE/3	3	12.2mm
CTBP92HE/4	4	16mm
CTBP92HE/5	5	19.8mm
CTBP92HE/6	6	23.7mm
CTBP92HE/7	7	27.5mm
CTBP92HE/8	8	31.3mm
CTBP92HE/9	9	35.1mm
CTBP92HE/10	10	38.9mm
CTBP92HE/11	11	42.7mm
CTBP92HE/12	12	46.5mm

CTBP92HE

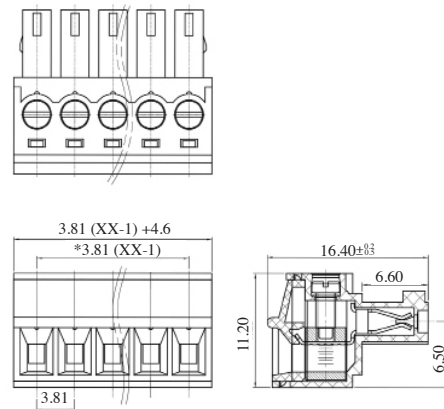

Female Connector Vertical (standard)

TYPE NO.	POLES	LENGTH
CTBP92VE/2S	2	8.4mm
CTBP92VE/3S	3	12.2mm
CTBP92VE/4S	4	16mm
CTBP92VE/5S	5	19.8mm
CTBP92VE/6S	6	23.7mm
CTBP92VE/7S	7	27.5mm
CTBP92VE/8S	8	31.3mm
CTBP92VE/9S	9	35.1mm
CTBP92VE/10S	10	38.9mm
CTBP92VE/11S	11	42.7mm
CTBP92VE/12S	12	46.5mm

CTBP92VE/S

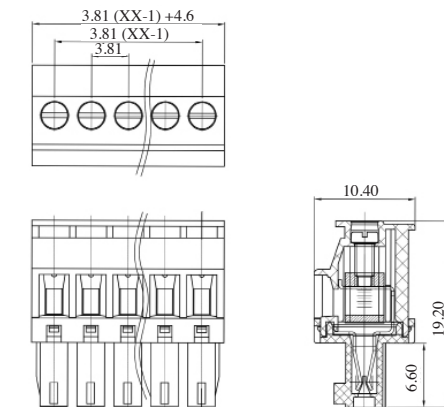

Female Connector Vertical

TYPE NO.	POLES	LENGTH
CTBP92VE/2R	2	8.4mm
CTBP92VE/3R	3	12.2mm
CTBP92VE/4R	4	16mm
CTBP92VE/5R	5	19.8mm
CTBP92VE/6R	6	23.7mm
CTBP92VE/7R	7	27.5mm
CTBP92VE/8R	8	31.3mm
CTBP92VE/9R	9	35.1mm
CTBP92VE/10R	10	38.9mm
CTBP92VE/11R	11	42.7mm
CTBP92VE/12R	12	46.5mm

CTBP92VE/R

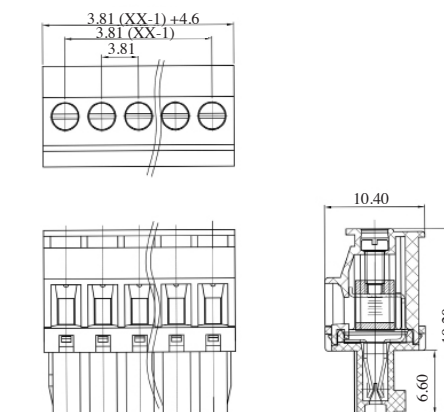

CAMBLOCK PLUS

PCB Mounting Male Horizontal (closed ended)

TYPE NO.	POLES	LENGTH
CTBP93HE/2	2	8.4mm
CTBP93HE/3	3	12.2mm
CTBP93HE/4	4	16.0mm
CTBP93HE/5	5	19.8mm
CTBP93HE/6	6	23.7mm
CTBP93HE/7	7	27.5mm
CTBP93HE/8	8	31.3mm
CTBP93HE/9	9	35.1mm
CTBP93HE/10	10	38.9mm
CTBP93HE/11	11	42.7mm
CTBP93HE/12	12	46.5mm

CTBP93HE

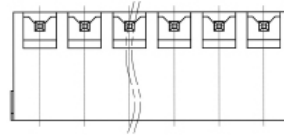
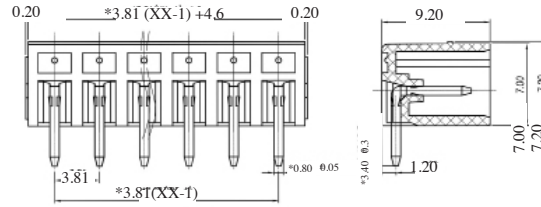
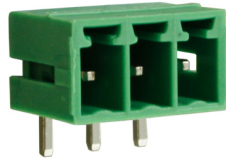

PCB Mounting Male Vertical (closed ended)

TYPE NO.	POLES	LENGTH
CTBP93VE/2	2	8.4mm
CTBP93VE/3	3	12.2mm
CTBP93VE/4	4	16.0mm
CTBP93VE/5	5	19.8mm
CTBP93VE/6	6	23.7mm
CTBP93VE/7	7	27.5mm
CTBP93VE/8	8	31.3mm
CTBP93VE/9	9	35.1mm
CTBP93VE/10	10	38.9mm
CTBP93VE/11	11	42.7mm
CTBP93VE/12	12	46.5mm

CTBP93VE

